

Viewports & Shutters

5

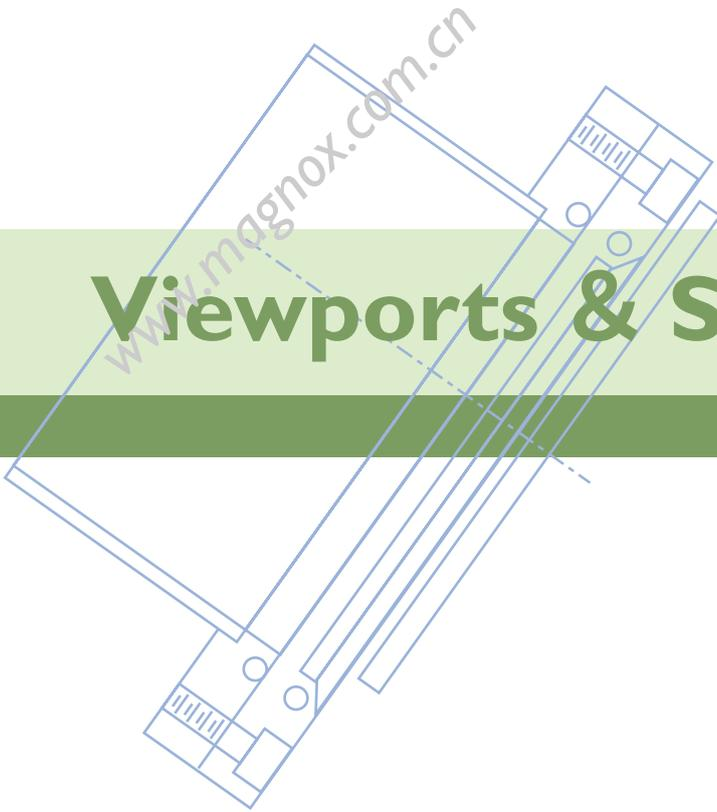

5.1 Zero Length Viewport.....	128-130
5.2 Demountable Viewport.....	131-132
5.3 Quick Access Doors	133
5.4 Glass Adapters.....	134
5.5 Viewport Stubs	134

MAGNOX Products offers a complete line of viewports for vacuum chambers with NW,ISO and CF flanges. CF flanged viewports are available with fully annealed 7056 glass or fused silica. Weld stub viewports are available for welding onto new or existing chambers. Special materials and coatings, such as sapphire and anti-reflective (AR) coating, are available on request. Glass provides a large distortion free viewing area at low cost. Quartz and fused silica provide superior ultraviolet radiation transmission and resistance to thermal shock.

MAGNOX manufactures glass adapters in 7740 Pyrex and 7052 glass. These adapters are useful for mounting glass accessories to metal high vacuum systems, or to attach flange mounted components to glass systems. Glass adapters are available with NW, CF, and ISO flanges as standards.

Zero Length Viewport Ordering Information

零长度视窗订购信息

66252		0275		FQ	
产品系列		代码	规格说明	产品类型	
66249	KF法兰	0133	CF16	KG	K9光学玻璃
66252	CF法兰	0075	KF16	FQ	石英
66253	ISO法兰	0212	CF25	FS	蓝宝石
		0100	KF25	CQ	晶体石英
		0275	CF35	MF	氟化镁
		0150	KF40	US	紫外蓝宝石
		0338	CF50	ZS	硒化锌
		0200	KF50		
		0450	CF63		
		0250K	ISO63-K		
		0462	CF80		
		0300K	ISO80-K		
		0600	CF100		
		0400K	ISO100-K		
		0600K	ISO160-K		
		0800	CF160		

说明

1. 型号说明仅用于说明型号组成规则，有些组合实际并不存在；如有疑问请联系迈格诺科销售代表。



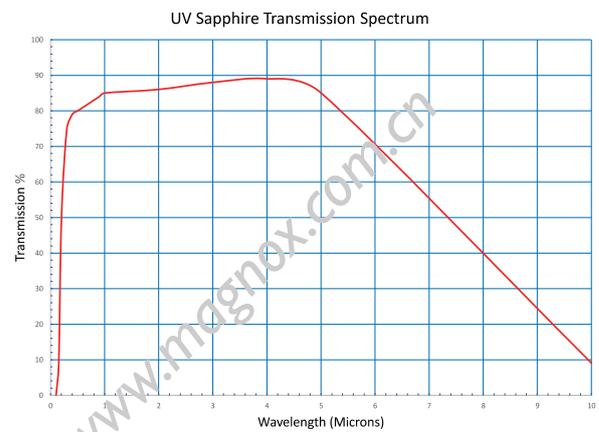
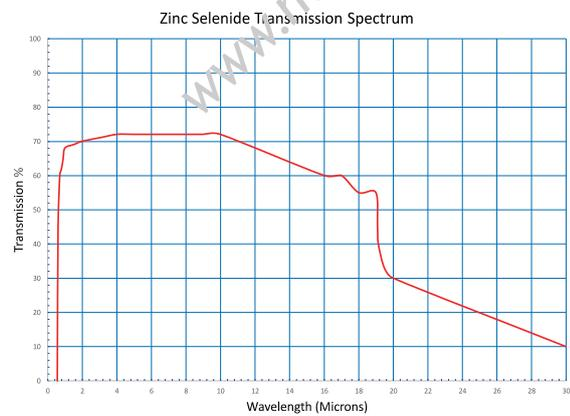
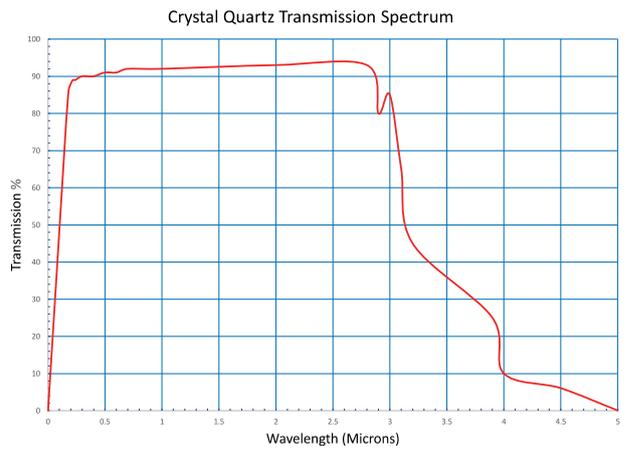
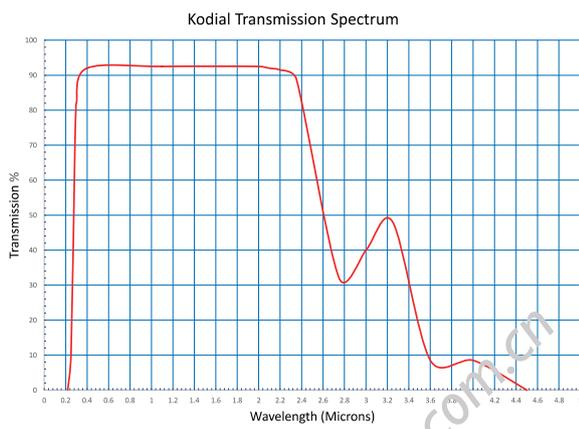
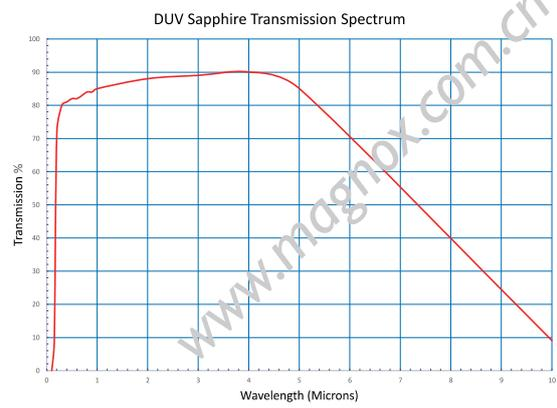
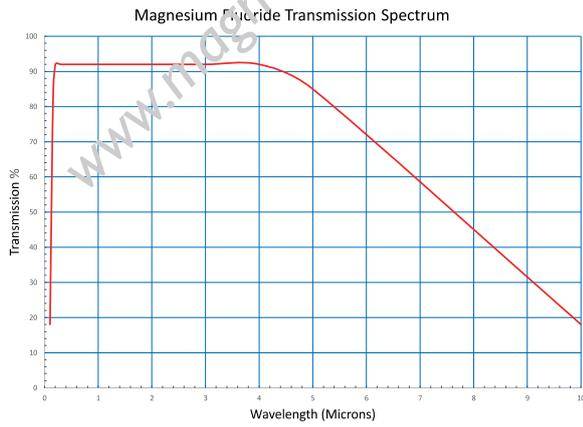

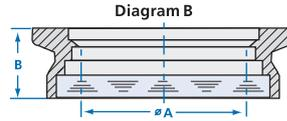
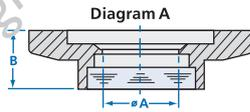

NW Viewports				
Part Number	Diagram	Flange Size	Dimensions, mm	
			View $\varnothing A$	B
66249-0075	A	NW-16	15.75	9.78
66249-0100	A	NW-25	15.75	9.78
66249-0150	B	NW-40	38.35	14.07
66249-0200	B	NW-50	38.35	14.07

注：因工艺所致，不同材质的视镜尺寸会有差异，具体数据请咨询迈格诺科销售工程师。

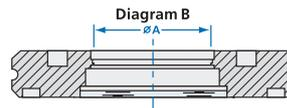
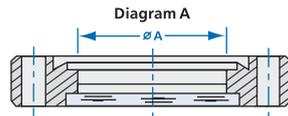

ISO&CF Zero Length Viewports				
Part Number	Diagram	Flange Type	Dimensions, mm	
			View $\varnothing A$	
66252-0133	A	1.33CF	16.00	
66252-0212	A	2.12CF	16.00	
66252-0275	A	2.75CF	37.85	
66252-0338	A	3.38CF	37.85	
66252-0450	A	4.50CF	67.56	
66252-0462	A	4.62CF	67.56	
66252-0600	A	6.00CF	100.84	
66252-0675	A	6.75CF	100.84	
66252-0800	A	8.00CF	142.24	
66252-1000	A	10.00CF	142.24	
66253-0250	B	ISO-63	37.85	
66253-0300	B	ISO-80	37.85	
66253-0400	B	ISO-100	67.56	
66253-0600	B	ISO-160	100.84	
66253-0800	B	ISO-200	142.24	

注：因工艺所致，不同材质的视镜尺寸会有差异，具体数据请咨询迈格诺科销售工程师。

Demountable Viewport Ordering Information

可拆卸视窗订购信息

66257		0275		FQ	
型号		尺寸规格		视镜材质	
66250	KF法兰	0133	CF16	FQ	石英
66251	KF法兰套装	0075	KF16	FS	蓝宝石
66254	ISO法兰	0212	CF25	UQ1	紫外石英增透膜245-400nm
66257	CF法兰	0100	KF25	UQ2	紫外石英增透膜350-700nm
		0275	CF35	UQ3	紫外石英增透膜650-1050nm
		0150	KF40	UQ4	紫外石英增透膜1050-1700nm
		0338	CF50		
		0200	KF50		
		0250K	ISO63-K		
		0250F	ISO63-F		
		0250N	ISO63-NW		
		0462	CF80		
		0300K	ISO80-K		
		0300F	ISO80-F		
		0300N	ISO80-NW		
		0600	CF100		
		0400K	ISO100-K		
		0400F	ISO100-F		
		0400N	ISO100-NW		
		0675	CF130		
		0600K	ISO160-K		
		0600F	ISO160-F		
		0600N	ISO160-NW		
		0800	CF160		
		0800K	ISO200-K		
		0800F	ISO200-F		
		0800N	ISO200-NW		
		1000	CF200		
		1000K	ISO250-K		
		1000F	ISO250-F		
		1000N	ISO250-NW		

说明

1、型号说明仅用于说明型号组成规则，有些组合实际并不存在；如有疑问请联系迈格诺科销售代表。

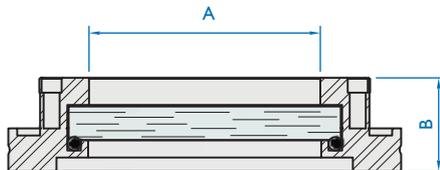

ISO-K Flange Demountable Viewports

Model Number	Flange Size	Dimensions, mm	
		A	B
66254-0250	ISO63	60.2	73.15
66254-0400	ISO80	97.28	73.15
66254-0600	ISO100	148.08	73.15



NW Zero Length Viewports				
Model Number	Dimensions, mm			
	Diagram	Flange Type	View Materials	View $\varnothing A$
66250-0150	A	NW-40	Fused quartz	32.00
66250-0200	A	NW-50	Fused quartz	41.40
66251-0150	B	NW-40	Fused quartz	32.00
66251-0200	B	NW-50	Fused quartz	41.40

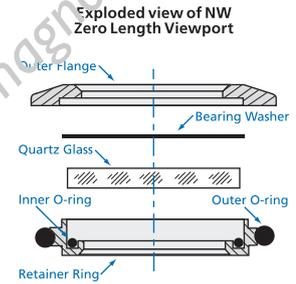

Weld stub viewports are provided with a tube for welding onto an existing chamber.

Viewport Weld Stubs				
Part Number	Flange OD	Dimensions, mm		
		View $\varnothing A$	B	C
66254-0250	113.54	60.2	73.15	63.50
66254-0400	151.64	97.28	73.15	101.60
66254-0600	202.44	148.08	73.15	152.40

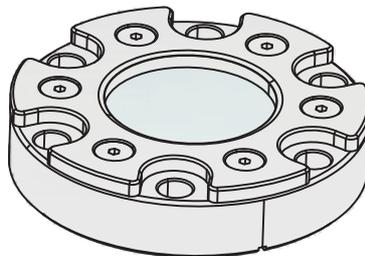
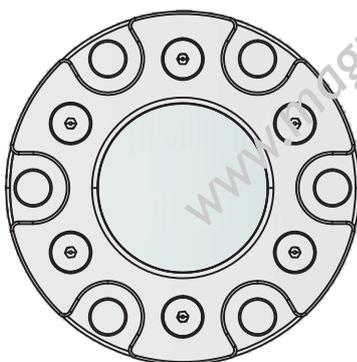
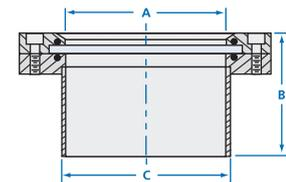

CF Zero Length Viewports			
Part Number	Flange Size	Dimensions, mm	
		View Diameter	Glass Thickness
66257-0133	CF1.33	14.22	4.00
66257-0275	CF2.75	30.23	4.00



Vacuum Quick Access Dorrs

真空快开门

An Add-A-Door can provide easy access to a vacuum system when elastomer seals are acceptable. The hinged, FKM sealed door is quickly bolted to an existing CF (Conflat style) flanged chamber port. The door is opened easily by turning a knurled knob. These doors are available for 2¾ to 10 inch (70 to 254mm) OD flanges with a solid metal door or with a viewport. The standard finish is electropolish. Custom sizes can be supplied upon request.

Technical Data for Quick Access Doors

Door Seal	FKM
Mounting Seal	CFHC gasket
Operate Pressure Range	1.000 mbar - 1.33x10 ⁻⁸ mbar
Leak Rate	1.33x10 ⁻⁹ mbar Vs, He
Temperature Range	-20°C (-4°F) ~ 150°C (302°F)
Bake Temperature	100°C (212°F)
Body Material	SS304L
Hinge Material	Optional high - grade SS316L material
Viewport Material	Glass (only with viewport version)
Mounting Position	Any

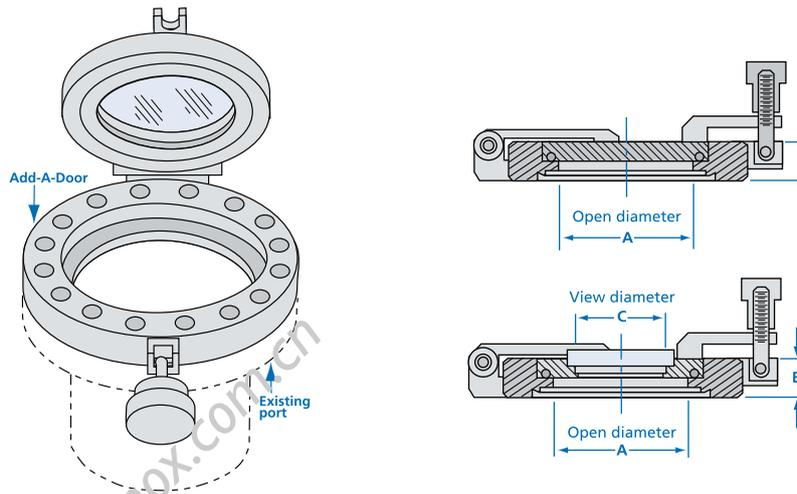

Quick Access Dorrs With Blank Flanges

Part Number	Dimensions, mm		
	Flange Type	A	B
66255-0275	2.75CF	35.05	12.70
66255-0450	4.50CF	61.85	17.45
66255-0600	6.00CF	99.49	19.84
66255-0800	8.00CF	149.23	22.23
66255-1000	10.00CF	200.03	24.59

Quick Access Dorrs With CF Flanges

Part Number	Dimension, mm			
	Flange Type	A	B	C
66256-0450	4.50CF	61.85	17.45	37.85
66256-0600	6.00CF	99.49	25.40	67.31
66256-0800	8.00CF	149.23	30.48	98.55
66256-1000	10.00CF	200.03	33.02	142.24

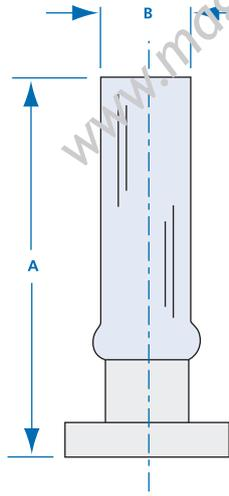

NW, ISO & CF Glass Adapters		
Part Number	Dimensions, mm	
	Flange Size	A
66246-0050	NW-10	124.46
66246-0075	NW-16	124.46
66246-0100	NW-25	124.46
66246-0150	NW-40	124.46
66246-0200	NW-50	137.16
66246-0250K	ISO-63	139.70
66246-0300K	ISO-80	165.10
66246-0400K	ISO-100	260.35
66246-0600K	ISO-150	276.35
66246-0133	1.33CF	137.92
66246-0212	2.12CF	137.67
66246-0275	2.75CF	138.68
66246-0338	3.38CF	151.89
66246-0450	4.50CF	197.10
66246-0462	4.62CF	194.56
66246-0600	6.00CF	265.18
66246-0675	6.75CF	278.38
66246-0800	8.00CF	279.40

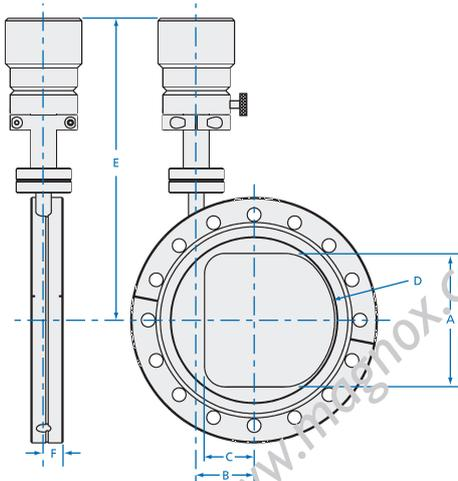

Viewport Stubs							
Part Number	Flange Size	Dimensions, mm					
		A	B	C	D	E	F
66248-0275	2.75CF	28.45	14.48	10.67	17.78	152.15	11.18
66248-0450	4.50CF	50.80	21.59	16.51	29.97	175.77	8.64
66248-0400	6.00CF	82.55	35.56	30.48	48.26	186.44	11.94
66248-0600	8.00CF	127.00	52.32	44.45	73.66	215.65	12.70

